

ELIA FL - Floodlight LED



ELIA FL is a LED outdoor floodlight available in low, medium and high power versions for lighting external industrial areas, such as car parks and walkways or driveways. It can be mounted on surfaces, ceilings or on the ground using the adjustable steel bracket supplied with the device, or in the pole head version, courtesy of the dedicated accessory for poles with a diameter of up to 61mm. Crafted from black powder-coated die-cast aluminium, it is available in four sizes and powers, with integrated power supply in the On/Off or DALI options, three types of optic (30°, 60° and asymmetrical) with a colour temperature of 4,000K (neutral white) and a colour rendering index of more than 80. Tough and durable, ELIA FL has been designed to withstand surges of up to 10KV and temperature variations from -30 °C to + 50 °C, and offers protection from water and dust penetration of up to level IP66 and from shocks and impacts of up to level IK08. ELIA FL is quick and easy to install thanks to its limited weight and adjustable bracket.

GENERAL INFORMATION		OPTIC AND ILLUMINATING FEATURES	
Context	Industry, Logistic, Façade, Sport	Optică	60°
Luminaire	LED luminaire with small, mid and high lumen power	Unified Glare Rating	ULOR = 0%
Aplicație	Intern / Extern	Lumină ieșire (lm)	6600
Unique digital code (Datamatrix)	Currently not present	Efficiency (lm/W)	132
Culoare	Negru	Culoare Temperatură	4000 K
Tip sursă de lumină	LED - Neînlocuibil	Color Rendering Index	CRI 80
Puterea sistemului	50 W	Standard Deviation Colour Matching	SDCM = 5
LED Lifetime	L80B50 (Tq25°) = 89.000h	Photobiological Risk Class	RG0
Greutate (Kg)	2.6	Standard	-
Garanție	5 ani	ELETRICAL AND LIGHTING FEATURES	
Temperatură de stocare	-40° +85°	Tensiune de alimentare	100-240 V
Operating temperature	-30° +50°	Frecvență nominală (Hz)	50 / 60
MATERIALS		Driver	Included
Body	Aluminiu turnat	Driver failure rate	F10 = 80.000h Tq25°C
Ecran	Flat silked tempered glass 4mm thick with Gewiss logo	Overvoltage protection	Overvoltage protection 6-4kV
Optic	With high efficiency optic system	Control System	PORNIT OPRIT
Gasket	-	INSTALLATION AND MAINTENANCE	
Locking Hook	-	Mouting and installation	Ceiling - Wall - Floor
External screw	Oțel	Tilt	With adjustable bracket assembled
Colour	Powder coating	Wiring	With power cable
STANDARDS AND APPROVALS		Prindere	-
Clasificare	-	Optic Maintenance	Not available
Dispozitiv cu temperatură la suprafață redusă	-	LED Maintenance	Not available
Certificare DIN 18032-3	-	Driver Box	Integrat
IPEA	-	Suprafață maximă expusă la vânt	0,05 m²
Clasă izolație	I		-
Clasă de protecție IP	IP66		-
Cod IK	IK08		-
Glow Test conductori	750 °C		-

DIMENSIONAL

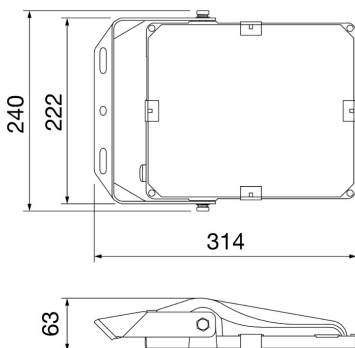

PHOTOMETRIC DISTRIBUTION

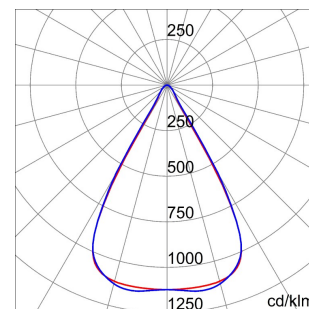

TECHNICAL SYMBOLOGY



IP

IP66

IK

IK08

GWT

750 °C

ELIA FL - Floodlight LED

STANDARDS/APPROVALS

